

DOKA LARGE-AREA FORMWORK TOP50 RETURN LIST

Company _____

Return Date _____

Project Name _____

Print Name _____

Final Return Yes/No (circle one)

Signature _____

Doka beams H20 top P

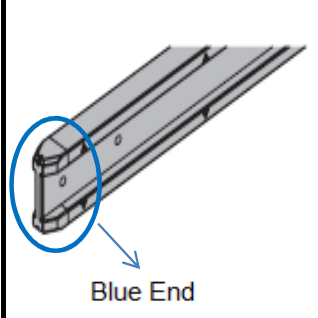

1.80m	
2.45m	
2.65m	
2.90m	
3.30m	
11'-6"	
3.60m	
3.90m	
4.50m	
16'-0"	
5.90m	

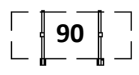

Doka beams H20 N

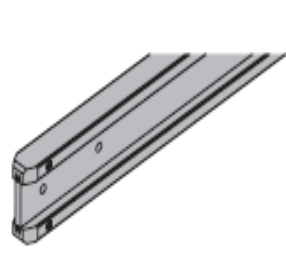

1.80m	
2.45m	
2.65m	
2.90m	
3.30m	
11'-6"	
3.60m	
3.90m	
4.50m	

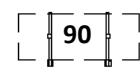

Multi-purpose waling WS10

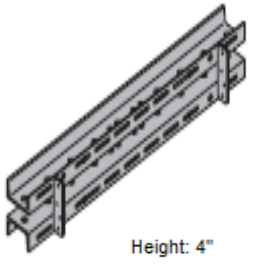

2'-6"	
3'-0"	
4'-0"	
5'-0"	
6'-0"	
7'-0"	
8'-0"	
10'-0"	
12'-0"	
14'-0"	
16'-0"	

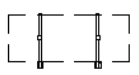

Multi-purpose waling WU12

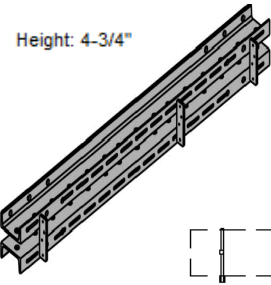

5'-0"	
6'-0"	



Corner waling WS10

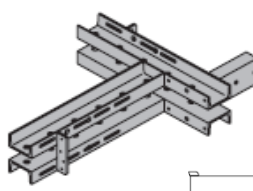

	2'-0"
3'-0"	
4'-0"	

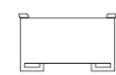

Flange clamp H20



Width: 5"
Width-across: 19 mm

300

nr: 580135000



Flange clamp G



Width: 5"
Width-across: 19 mm

400

nr: 580120000



C5 Channels

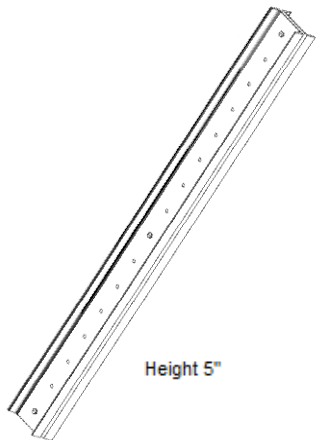

Height 5"

	Single	Double Assembly
2'-0"		
4'-0"		
6'-0"		
8'-0"		
10'-0"		
12'-0"		
14'-0"		
16'-0"		
18'-0"		
20'-0"		



C8 Channels

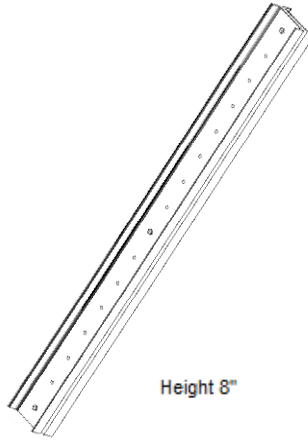

Height 8"

	Single	Double Assembly
2'-0"		
4'-0"		
6'-0"		
8'-0"		
10'-0"		
12'-0"		
14'-0"		
16'-0"		
18'-0"		
20'-0"		



Waling clamp H20

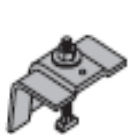

Width: 3 1/4"
Width-across: 13 mm



nr: 580114000



Channel wale spacer 2"



nr: 585044000



Lifting bracket



Height: 1'-11"

100

nr: 580460000



Beam screw S 8/60



Length: 2 3/4"
Width-across: 13 mm

nr: 580116000



Beam screw H 8/70



Length: 3 1/4"
Width-across: 13 mm

6000

nr: 580117000



Splice plate S 3" x 1/2"

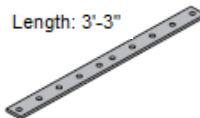

Length: 3'-3"

300

nr: 581620000

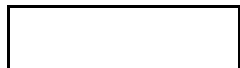

Splice plate S

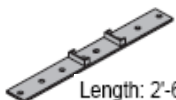

Length: 2'-6"

150

nr: 581614000



Beam clamp

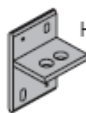

Height: 6"

250

nr: 580081000

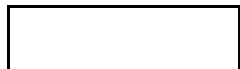

Adjustable waling extension S FF20

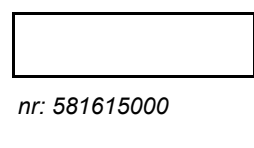
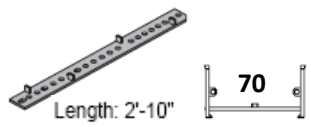

nr: 581615000

Internal angle plate S H20

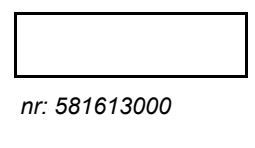
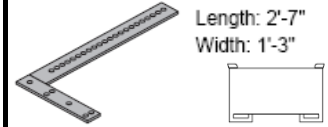

nr: 581613000

Half splice plate

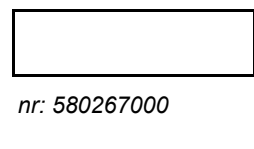
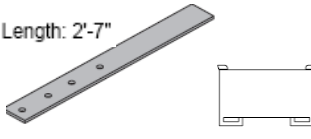

nr: 580267000

Universal angle tie bracket

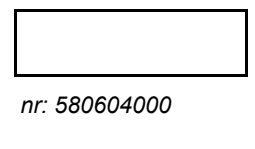
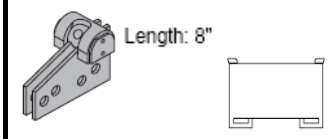

nr: 580604000

Corner connecting plate 90/50

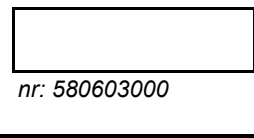
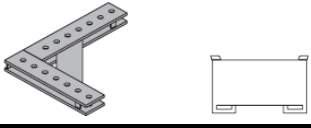

nr: 580603000

Connecting pin 25cm

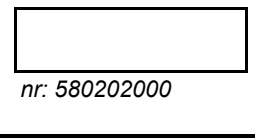
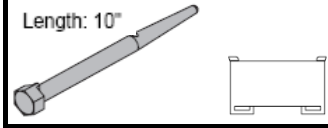

nr: 580202000

Connecting pin 10cm

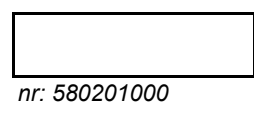
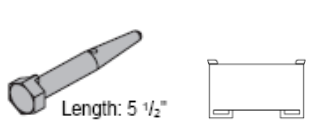

nr: 580201000

Stacking plate H20

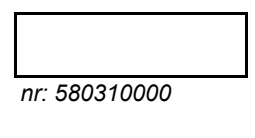
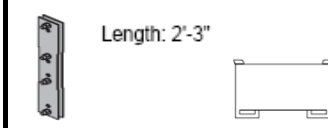

nr: 580310000

Spring cotter 6mm

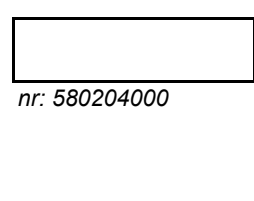
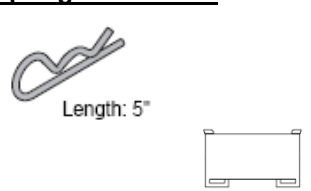

nr: 580204000

Transition plate s 3/4"

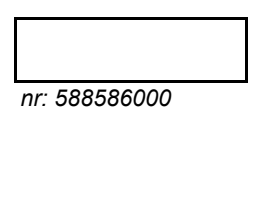
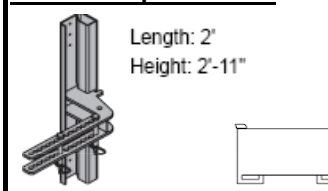

nr: 588586000

Inside corner plates



3.00m	
4.00m	
5.00m	

Adjusting Struts

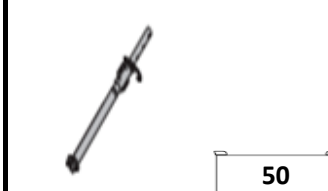

120	220

Joint plates

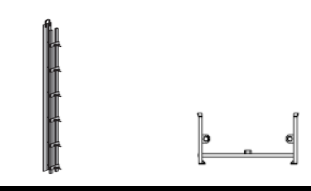

3.00m	
4.00m	

Plumbing Struts

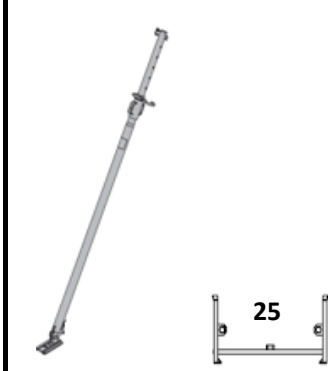

340	540

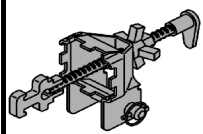
Prop head**100**

nr: 588244000

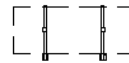
**Pipe braces**

22'-0" -40'-0"

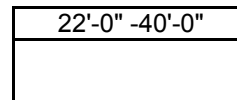
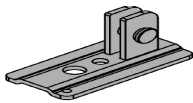
**Prop shoe****200**

nr: 588245000

**Handrail clamp S**

Height: 4' - 5'-7"

**40**

nr: 580470000

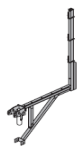
**Universal bracket 90**Length: 4'
Height: 7'-9"**10**

nr: 580476000

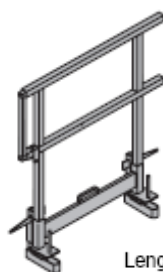
**Side handrail clamping unit T**Length: 3'-9" - 5'-9"
Height: 3'-8"

nr: 580488000

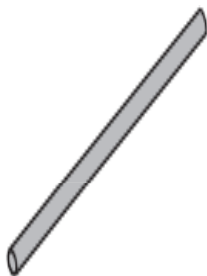
**Scaffolding tube**

1 1/2"

6'-0"

8'-0"

10'-6"

13'-0"

15'-0"

21'-0"

		1 1/2"
6'-0"		
8'-0"		
10'-6"		
13'-0"		
15'-0"		
21'-0"		

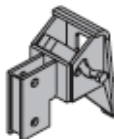
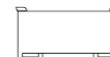
Suspension head WS10Length: 8"
Width: 7"
Height: 9"

nr: 580449000

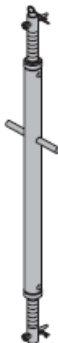
**Spindle strut (cm)**

T6	100/150	
T7	150/200	
T7	200/250	
T7	250/300	
T7	305/355	
T10	350/400	

Scaffold tube connection

Height: 2 3/4"

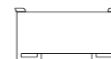

nr: 584375000

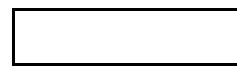
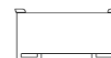
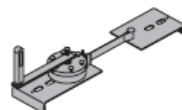
**Strip tensioner B 5.00m**

nr: 580394000

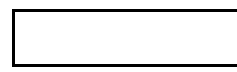

Assembly angle

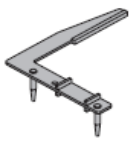

Length: 1'-10"
Width: 1'-7"



nr: 580082000

Super plate 15.0



Height: 2 1/4"
Diameter: 4 1/2"
Width-across: 27 mm



nr: 581966000

Tie Rods 15.0mm



0.50m	
0.75m	
1.00m	
1.25m	
1.50m	
1.75m	
2.00m	
5/8"x12'-0"	

Wing nut 15.0

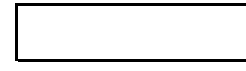
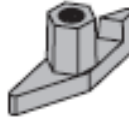

nr: 581961000

Super plate 20.0 B

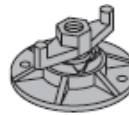

Height: 2 3/4"
Diameter: 5 1/2"
Width-across: 34 mm

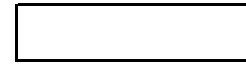

nr: 581424000

Hexagon nut



15.0	
20.0	

She-bolts

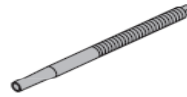

	1 1/4"
14"	
20"	

Taper ties



	1 1/4"
36"	
42"	
48"	
54"	
60"	
66"	
72"	

Flat washers

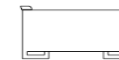
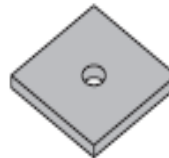

1"	1 1/4"

Wing nuts



1"	1 1/4"

Packaging - Must Be Counted!

Qty.			

Item	Description	Qty.